

# FORAGE BAG

Designed by Anna Graham of Noodlehead for RK  
[www.noodle-head.com](http://www.noodle-head.com)



A petite set of cross body bags. Zippered front opening is perfect for easy and secure access to your most important items and elegant darts help bring shaping to the bag as well as adding sophisticated detail. Interior pocket (regular size only) is perfect for a pen and phone.

Approximate finished dimensions:  
9" wide, 2" deep, 11-1/2" tall regular {7" wide, 1-1/2" deep, 9" tall mini}

Difficulty Rating: **Beginner**

**ROBERTKAUFMAN**  
F A B R I C S

For questions about this pattern, please email [Patterns@RobertKaufman.com](mailto:Patterns@RobertKaufman.com).

## Fabric and Supplies Needed

Fabric amounts based on yardage that is 44" wide.

### Regular Bag



Fabric      Yardage

Exterior

1/2 yard

Lining

1/2 yard

Accent

1/4 yard  
OR  
fat quarter

### Mini Bag



Fabric      Yardage

Exterior

1/2 yard

Lining

1/2 yard

Accent

1/4 yard  
OR  
fat quarter

*\*Mini size noted in { } throughout.*

You will also need:  
1-3/4 {1} yards fusible woven interfacing (Pellon SF101 - 20" wide  
one 8" {6"} zipper\* for exterior zip pocket  
two 3/8" metal grommets (Dritz brand, setting tool needed as well)

Copyright 2018, Robert Kaufman  
For individual use only - Not for resale

Recommended Fabrics: Lightweight Canvas (6-7 oz. weight) or medium weight quilting fabric for exterior fabric and accent fabric. Quilting cotton for Lining.

\*= pattern assumes zipper tape width of 1 inch.

Additional supplies + tools:

Polyester thread, water-soluble pen/tailor's chalk, cutting mat, ruler, rotary cutter, size 14 or 16 denim or Microtex needle, glue pen (Sewline glue pen is my favorite), 25mm bias tape maker (optional), seam sealant (such as Fray-Check, optional)

## Notes Before You Begin

- Read through all of the instructions before beginning.
- All of the seam allowances are 1/2" unless otherwise noted.
- All of the basting seam allowances are 1/4" unless otherwise noted.
- Make sure to backstitch at beginning and end of each seam to secure stitches.
- Press seam allowances open unless otherwise noted.
- Topstitch 1/8" away from edges or seams.
- Use a longer stitch length when topstitching (2.8-3.0mm)
- Width of fabric (WOF) is equal to at least 44" wide.
- Right sides together has been abbreviated to RST.
- Wrong sides together has been abbreviated to WST.
- Remember to measure twice and cut once!



Right side



Wrong side

## Cutting Instructions

*Please note that pieces are cut from pattern pieces as well as rectangular measurements. Use a gridded ruler, rotary cutter, and cutting mat to cut the rectangular pieces to size.*

*Mini size noted in { } throughout.*

### **From Exterior fabric:**

Two Main Panels (cut one, then cut one to dotted line)

Two Straps - 2" tall x 30-1/2" wide

Four 1" tall x 2-1/2" wide Zipper End Tabs

### **From Lining fabric:**

Two Main Panels (cut one, then cut one to dotted line)

Two 6-1/2" tall x 7" wide Interior Slip Pockets

Two 2"-wide bias cut strips, to be made into approx. 1 {3/4} yards of bias tape binding. See instructions on Page 5.

### **From Accent fabric:**

Two Top Accents

### **From Fusible Woven Interfacing (20"-wide):**

One Strap - 60" tall x 2" wide {Two 30" tall x 2" wide Straps}

Four Main Panels (cut two, then cut two to dotted line)

Two Top Accent

One 6-1/2" tall x 7" wide Interior Slip Pocket

## Prepare

**Step 1:** Fuse fusible woven interfacing to the wrong side of each corresponding **exterior, lining, and accent** pieces. Only one Interior Slip Pocket (if making regular size) will be interfaced. Do not fuse interfacing to strap. That will be done in a later step.

**Step 2:** Main Panel pieces cut to dotted line will be referred to as Front Panel pieces, Main Panel pieces cut to full pattern piece height we be referred to as Back Panel pieces. With a water soluble pen, mark on the interfacing indicating which piece is which so as to avoid confusion during construction.

**Step 3:** Transfer dart markings to all Main Panel pieces. You'll have two Main Panel pieces from the exterior fabric and two from the lining fabric, marking 8 darts total.

**Step 4:** To sew a dart, fold the fabric RST with dart legs aligned. Sew along the marked dart line. Repeat for remaining darts, again there will be 8 darts total.

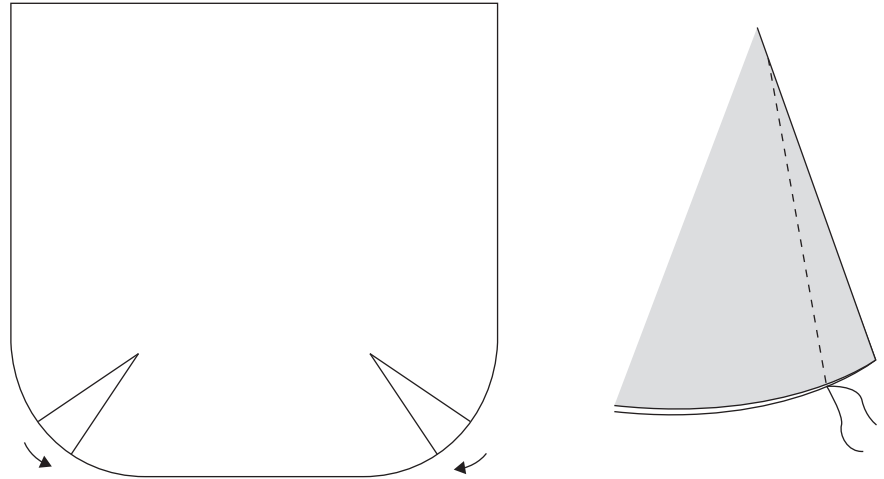

Figure 1

**Step 5:** On exterior Main Panel darts, press dart in toward center of panel. On right side, topstitch along dart fold. This holds the dart in place as well as adding detail!

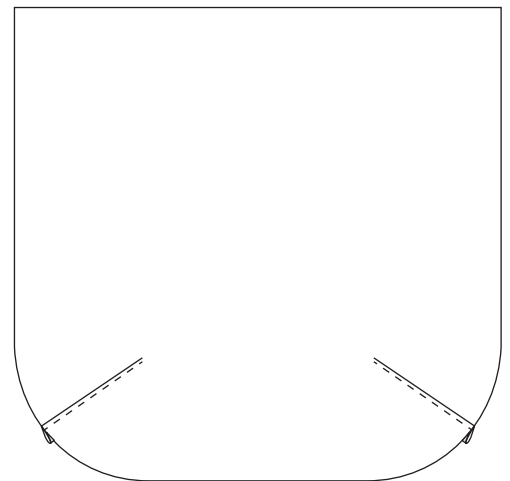

Figure 2

## Make Strap

**Step 1:** Place strap pieces RST and sew along one short end. Press seam open. Fuse interfacing {end-to-end for mini} on wrong side.

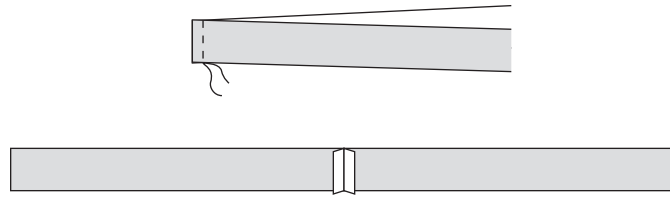

Figure 3

**Step 2:** Fold strap in half lengthwise WST. Open and press raw edges to center crease. Fold in half again and press. Strap will be 1/2" wide.

**Step 3:** Topstitch along open long edge. Set strap aside.

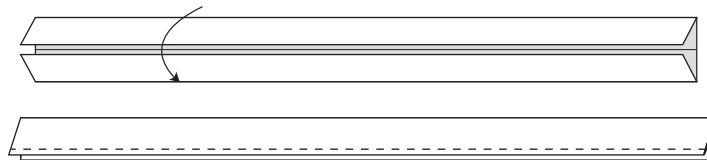

Figure 4

## Prepare Bias Binding

*The bias binding will be prepared similarly to the Strap. Feel free to use a bias tape maker to speed up the process!*

**Step 1:** Join strips by placing RST at a 90-degree angle. Sew along angled edge using a 1/4" seam allowance. Press seam open.

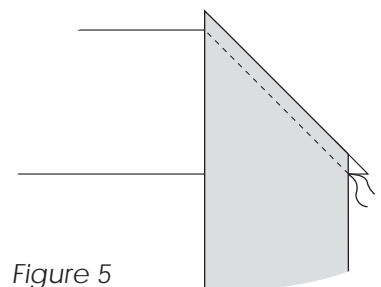

Figure 5



Figure 6

**Step 2:** Fold continuous strip in half lengthwise WST. Open and press raw edges to center crease (or use bias tape maker and follow manufacturer's instructions). I find that spray starch works great for nice crisp edges.

**Step 3:** Fold in half again and press. Now you'll have 1/2"-wide double fold bias binding. Set aside.

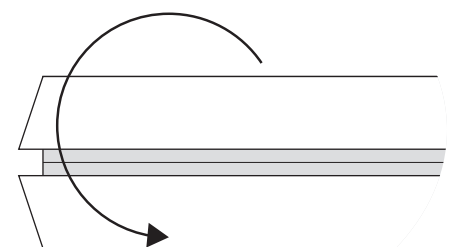

Figure 7

## Make and Attach Interior Slip Pocket (Regular size only)

**Step 1:** Place Interior Slip Pocket pieces RST. Sew along all edges leaving a 4" opening along one side edge. Clip corners and turn right side out. Use turning tool (or chopstick) to push out corners. Press.

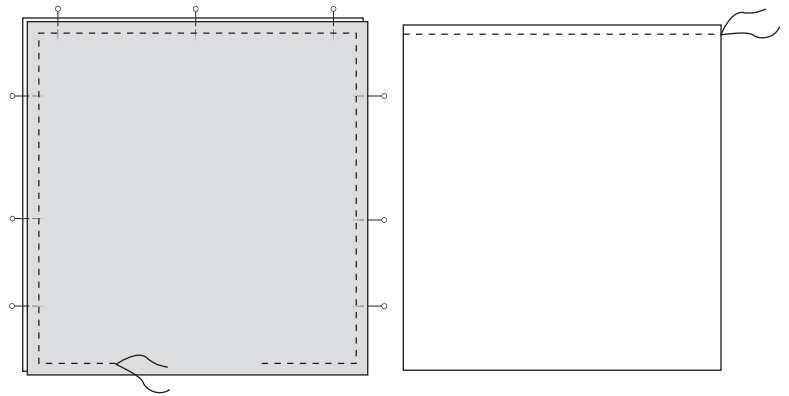

Figure 8

**Step 2:** Topstitch along top (6") pocket edge. Add additional row of topstitching as desired.

**Step 3:** Center pocket 1-1/2" down from top (straight edge) on lining Back Panel piece. Pin in place.

**Step 4:** Sew along sides and bottom of pocket, beginning and ending with a small narrow triangle in each corner for reinforcement.

**Step 5:** Mark a vertical line 1-1/2" from right edge of pocket. Topstitch on marked line, beginning at bottom edge of pocket. Set aside.

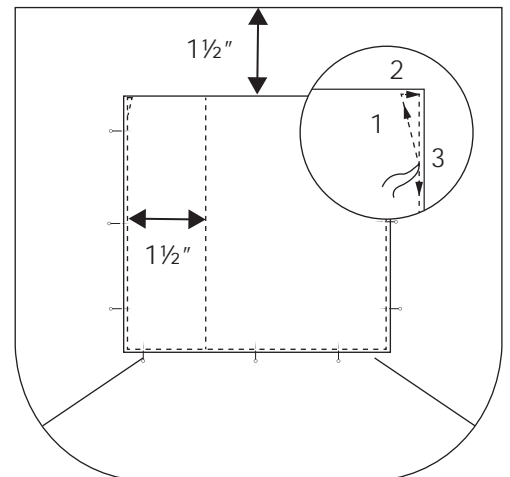

Figure 9

## Prepare Zipper

Press one short end of each Zipper End Tab to the wrong side by 1/2". End Tabs will now measure 1" tall by 2" wide. Place folded edge aligned to just past the zipper end stop. Two End Tabs will be sandwiching the zipper. Topstitch in place. Repeat for remaining End Tabs and remaining zipper end. *TIP: Glue will be very helpful for keeping these little pieces in place before you topstitch.*

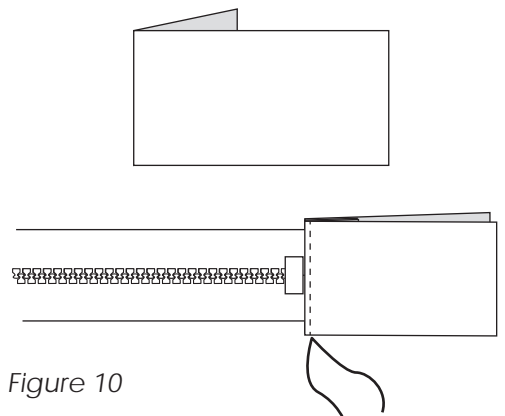

Figure 10



## Assemble Bag

**Step 1:** With exterior Front Panel right side up, center prepared zipper right side down (zipper pull at left) on top aligned to top straight edge. Glue or pin in place along zipper tape.

**Step 2:** Place lining Front Panel right side down on top of zipper, aligned to zipper tape. Pin in place. With zipper foot, sew along the 'zipper sandwich' using a **1/4" seam allowance**.

**Step 3:** Press Front Panel pieces away from zipper, WST.

**Step 4:** Trim away excess Zipper End Tab from each side.

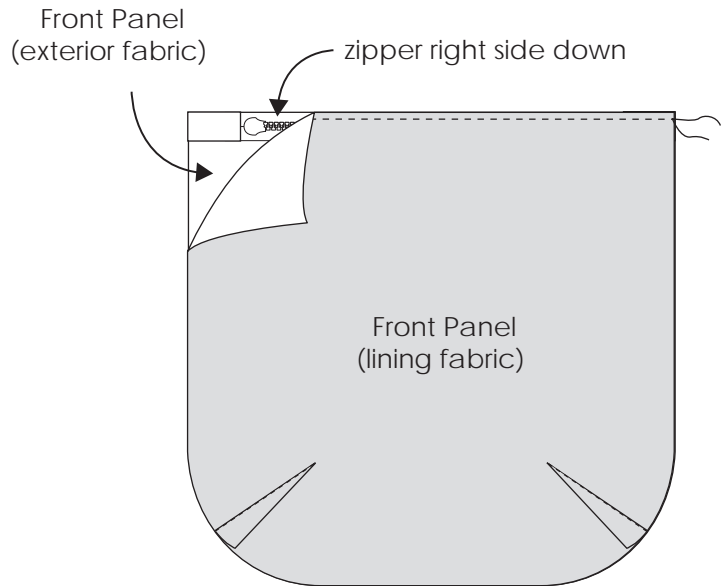

Figure 11

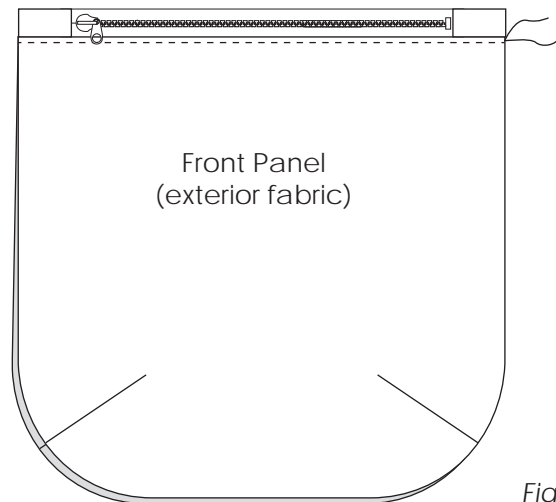

Figure 12

**Step 5:** Topstitch along zipper through all layers.

**Step 6:** With one Top Accent right side up, place remaining zipper tape on top aligned to one long edge, zipper will be facing right side up and exterior Front Panel will be facing right side up. Glue or pin in place along zipper tape.

**Step 7:** Place remaining Top Accent piece right side down on top, aligned to zipper tape. Pin in place. With zipper foot, sew along the 'zipper sandwich' using a **1/4" seam allowance**.

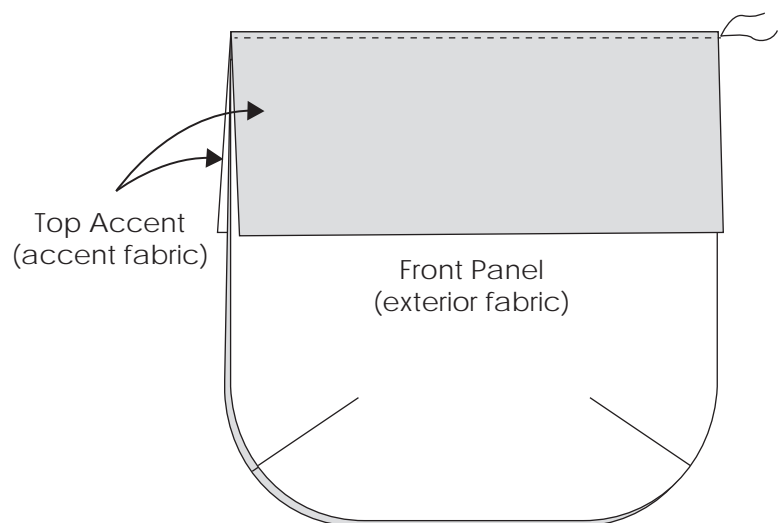

Figure 13

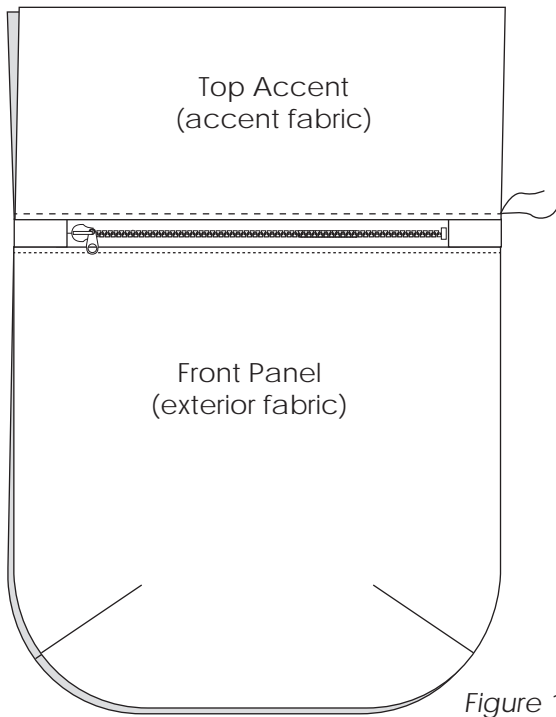

Figure 14

**Step 8:** Press Top Accent pieces away from zipper, WST. Topstitch along zipper through all layers.

**Step 9:** With one lining Back Panel (with pocket) right side up, place Top Accent on top, aligned to long edge. Lining side of completed Step 8 unit will be RST with lining Back Panel. Place exterior Back Panel right side down on top of Top Accent. Pin in place. Four layers will be pinned together here: the exterior Back Panel, the remaining raw edges of the two Top Accents, and the lining Back Panel.

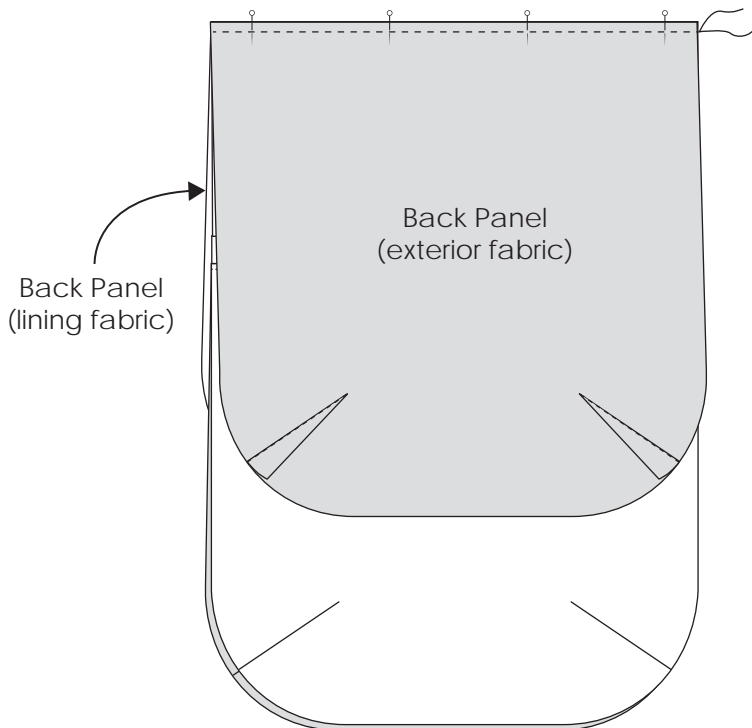

Figure 16

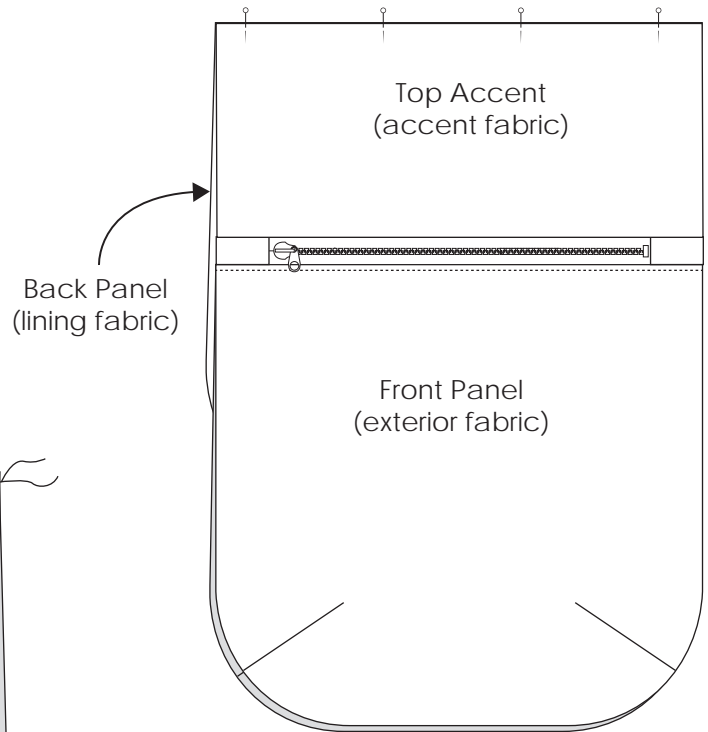

Figure 15

**Step 10:** Sew using a *1/4" seam allowance*.



**Step 11:** Press Back Panel pieces away from Top Accent, WST.

**Step 12:** Topstitch along exterior Back Panel fabric along the Top Accent seam through all layers.

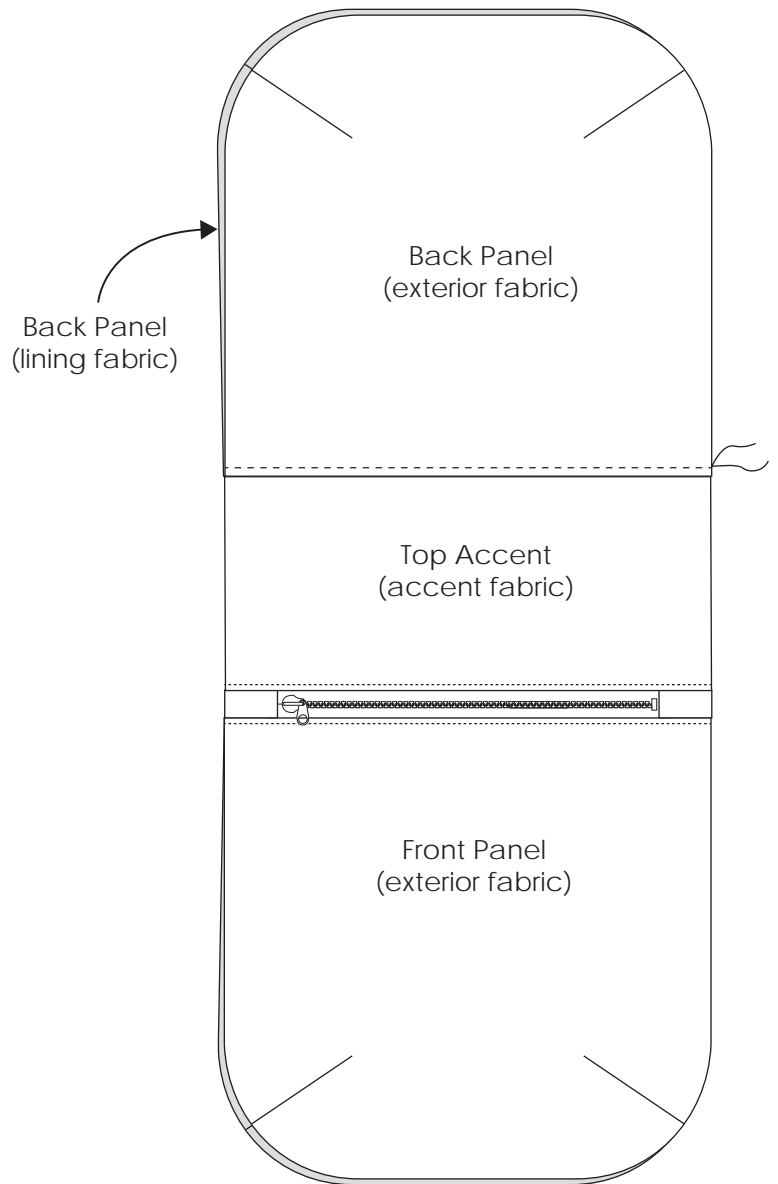

Figure 17

## Construct Bag

**Step 1:** Machine baste layers together with wrong sides of the fabric together, around entire perimeter using a 1/4" seam allowance. *Note: Exterior and lining of the front will be wrong sides together, and exterior and lining of the back will be wrong sides together. TIP: Finger press darts in opposing directions to 'nest' the dart seam and reduce bulk.*

**Step 2:** Open zipper halfway.

**Step 3:** Fold assembled bag in half with exterior pieces RST. Pin being sure to match up darts and Top Accent/Main Panel exterior pieces along the side seams. Sew around the left, bottom and right edges using a 1/2" seam allowance. Clip corners.

*Note:*

*Finish the inside raw edge with the bias binding strip you prepared earlier. Because the upper top edge of the bag will not be seen once the grommets are installed in the next step, the bias tape at the top corners of the bag can be left raw.*

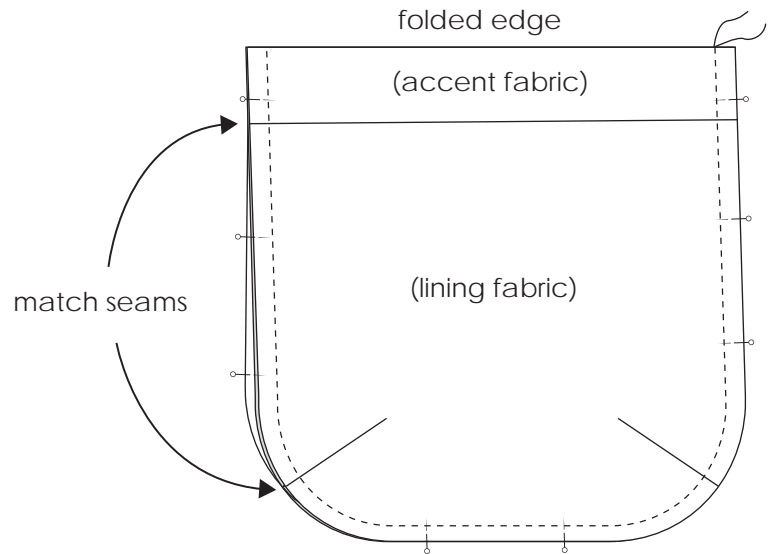

Figure 18

**Step 4:** Unfold binding and align long raw edge with raw edge of bag. Right side of binding will be facing right side of lining Front/Back Panel. Beginning at top corner, sew binding in place by sewing on the first crease of binding (towards raw edge of bag).

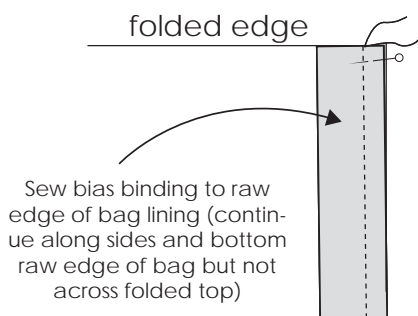
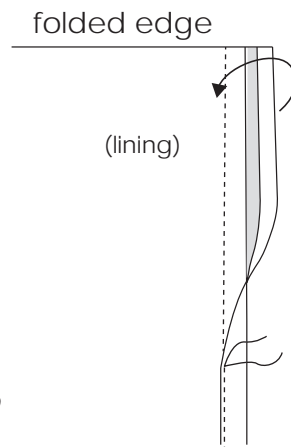

Figure 19



**Step 5:** Wrap binding around raw edge of seam, just covering the previous stitching. It will help to press the binding, especially at the curved corners. Pin or clip binding in place. Sew binding in place close to inner folded edge of binding.

**Step 6:** Slide zipper all the way open, turn bag exterior side out. Press carefully along curved bottom edges to get a nice smooth edge.

## Install Grommets

**Step 1:** Make a mark 1" from top and 1-1/2" {1"} from each side edge of Top Accent. Mark grommet hole on Top Accent by centering grommet over marking and tracing the inner diameter of grommet onto Top Accent piece using a water-soluble pen. Using a sharp scissors, cut hole through all layers of Top Accent.

**Step 2:** Set both grommets by inserting grommet post through front side of the bag, flipping bag over, and placing grommet washer over grommet post. Use the setting tool for your particular grommet to set each grommet by hammering it secure. Grommets will be snug to the fabric when set correctly.

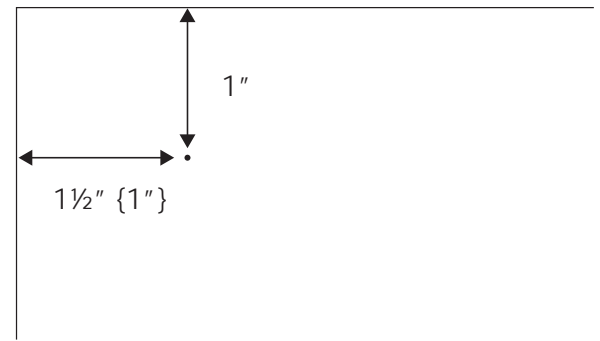
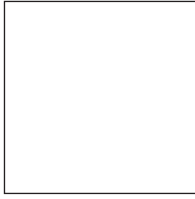

Figure 20

## Insert Strap

Thread Strap through grommet and double knot to secure in place. Trim excess end of raw edge of Strap at an angle and seal with seam sealant if desired. Repeat for remaining end of Strap through remaining grommet, adjusting overall length if needed.

That's all! Enjoy using your new bag!



**Test Box:**  
When printed at 100% this box will measure 1" square.

Cut to dotted line for Front Panel

PLACE ON FOLD

## FORAGE BAG Main Panel (Regular)

Cut 8 on fold:  
2 exterior fabric (cut 1, then cut 1 cut to dotted line)  
2 lining fabric (cut 1, then cut 1 cut to dotted line)  
4 fusible woven interfacing (cut 2, then cut 2 cut to dotted line)

*noodlehead*

Designed by Anna Graham for Robert Kaufman Fabrics  
All rights reserved.  
www.noodle-head.com 2018

dart (mark on all pieces)

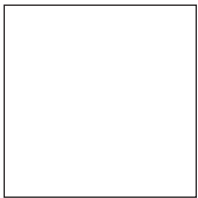

**Test Box:**  
When printed at  
100% this box will  
measure 1" square.

**FORAGE BAG**  
**Top Accent (Regular)**  
Cut 4  
2 accent fabric  
2 fusible woven interfacing

*noodlehead*  
Designed by Anna Graham for Robert Kaufman Fabrics  
All rights reserved.  
[www.noodle-head.com](http://www.noodle-head.com) 2018

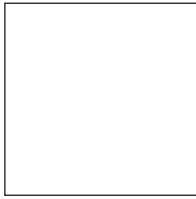

**Test Box:**  
When printed at  
100% this box will  
measure 1" square.

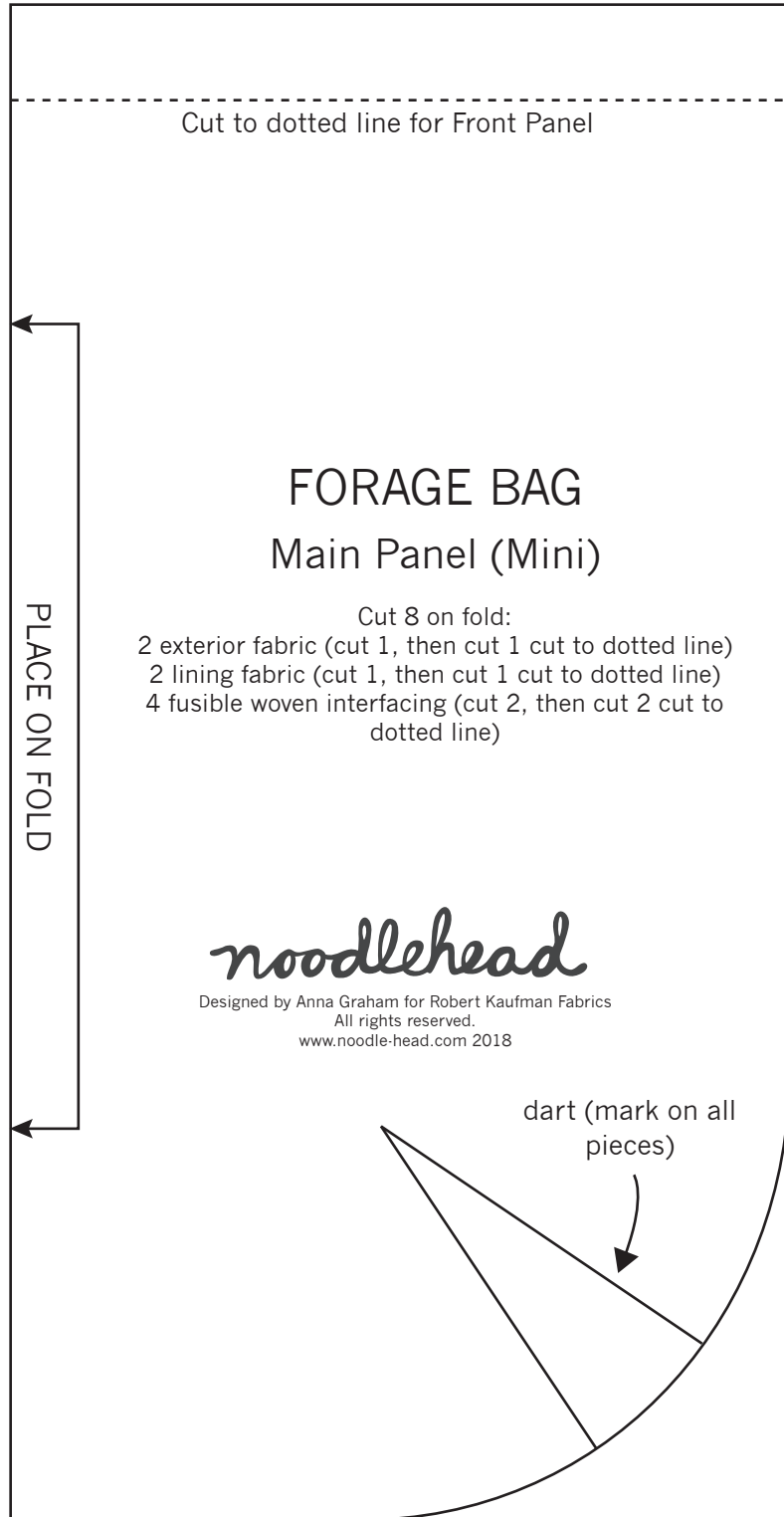



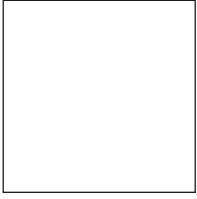

**Test Box:**  
When printed at  
100% this box will  
measure 1" square.

**FORAGE BAG**  
**Top Accent (Mini)**

Cut 4  
2 accent fabric  
2 fusible woven interfacing

*noodlehead*

Designed by Anna Graham for Robert Kaufman Fabrics  
All rights reserved.  
[www.noodle-head.com](http://www.noodle-head.com) 2018