

INTERMEDIATE  
SKILL

# Pines and Twine Tree Skirt

Designed by Stacey Day

Featuring Holiday Greetings by Jean Plout

SIZE: 48" diameter

FREE  
PROJECT



THIS IS A DIGITAL REPRESENTATION OF THE QUILT TOP, FABRIC MAY VARY.

**PLEASE NOTE:** BEFORE MAKING YOUR PROJECT, CHECK FOR ANY PATTERN UPDATES AT [WINDHAMFABRICS.COM](http://WINDHAMFABRICS.COM)'S FREE PROJECTS SECTION.





# Pines and Twine Tree Skirt

KEY	FABRIC	SKU	YD	CUTTING INSTRUCTIONS
A		53607-6 White	2-1/2	(12) 2-1/2" x WOF strips. Subcut (32) 2-1/2" x 9-1/2" and (32) 2-1/2" x 3-3/4" rectangles. (2) 1-3/4" x WOF strips. Subcut (32) 1-3/4" x 2-1/4" rectangles. (2) 1-3/4" x WOF strips. Subcut (32) 1-3/4" squares, cut once diagonally to make (64) HSTs. (16) Template 1. (16) Template 2. (16) Template 4.
B		53607-7 Forest	1-1/2	(1) 25" square; cut into 2-1/4" wide bias strips to create 200" of bias binding. (6) 2-1/2" x WOF strips. Subcut (16) 2-1/2" x 7-1/4" and (16) 2-1/2" x 5-1/2" rectangles. (2) 2-1/4" x WOF strips. Subcut (16) 2-1/4" x 4" rectangles.
C		53603-3 Black	1/2	(8) Template 3.
D		53608-5 Ruby	1/4	(4) Template 3.
E		53608-7 Forest	1/4	(4) Template 3.
F		53604-2 Ivory	1/4	(2) 2-1/2" x WOF strips. Subcut (4) 2-1/2" x 5-1/2" and (4) 2-1/2" x 4" rectangles and (4) 2-1/2" squares.
G		53604-3 Black	1/4	(2) 2-1/2" x WOF strips. Subcut (4) 2-1/2" x 5-1/2" and (4) 2-1/2" x 4" rectangles and (4) 2-1/2" squares.
H		53603-1 Pine	1/4	(2) 2-1/2" x WOF strips. Subcut (4) 2-1/2" x 5-1/2" and (4) 2-1/2" x 4" rectangles and (4) 2-1/2" squares.
I		53603-2 Ivory	1/4	(2) 2-1/2" x WOF strips. Subcut (4) 2-1/2" x 5-1/2" and (4) 2-1/2" x 4" rectangles and (4) 2-1/2" squares.
J		53607-3 Black	1/8	(1) 2" x WOF strip. Subcut (16) 2" x 2-1/2" rectangles.
K		53608-3 Black	3-1/4	(16) 1-3/4" x 2-1/2" use remaining for backing
		Piece of Batting	56" x 56"	



# Pines and Twine Tree Skirt

## Sewing Instructions:

All seam allowances are 1/4". Pieces are sewn right sides together. Press all seams open. This pattern assumes a basic knowledge of Foundation paper piecing.

**1. Pine Tree Units:** Complete the (16) Foundation 1 units as shown, piecing fabric in the number order given. Trim foundations units on the outside solid line. Leave the paper intact.

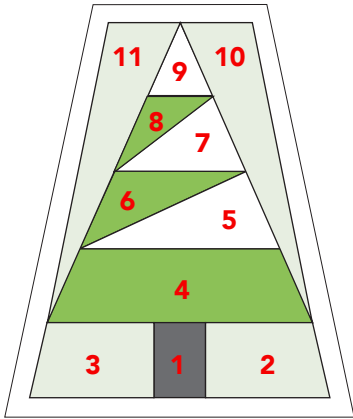

FOUNDATION 1

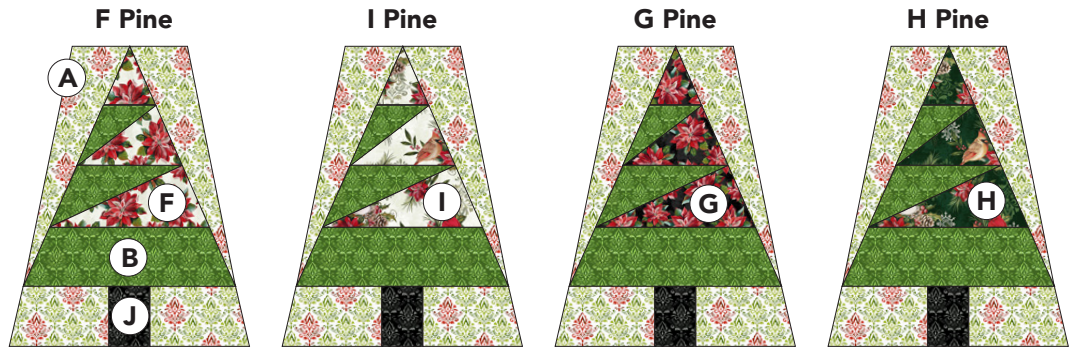

MAKE (4) OF EACH

## 2. Tree Top Units:

Similar to Foundation 1 piecing, make Foundation 2 units. **NOTE:** Foundation 2 sections 2-5 are pieced using **A** half-square triangles.

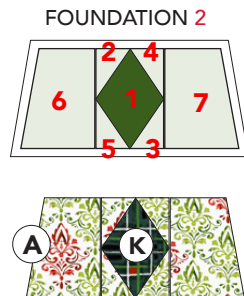

**3. Add **A** Template 4** to top of Foundation 2 units to complete tree top. Make (16) tree top units.

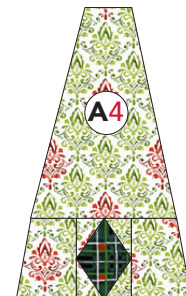

**4. Tree Bottom Units:** Sew **A** Templates 1 and 2 pieces to sides of **D**, **C** and **E** Template 3 pieces as shown.

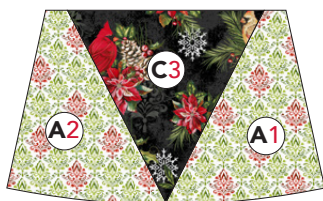

MAKE (8)



MAKE (4)



MAKE (4)



# Pines and Twine Tree Skirt

**5. Pine Tree Wedges:** Sew Tree Top units and Tree Bottom units to Pine Tree units as shown. Make (4) of each unit.



**Tree Skirt Assembly** *Refer to skirt diagram on page 3.*

**6. Quarter Units:** Sew (4) pine tree wedges into four quarters as shown.

**7. Half Units:** Sew (2) quarter units into two halves.

**8.** Sew the halves together, leaving one side open. Remove all the papers.

## FINISHING

Layer the backing right side down, batting, and tree skirt top right side up, easing so that the open raw edges of the tree skirt top meet, but do not overlap. Baste the layers together and quilt as desired. Trim excess batting and backing around the outside circle, between the raw edges, and the inside circle.

Bind with **B** 2-1/4" strips, using diagonal seams to make a bias binding. Sew the binding around the entire outer circle, inner circle and (2) open edges of the tree skirt. Turn the binding to the back and secure in place by hand or machine.





# Pines and Twine Tree Skirt

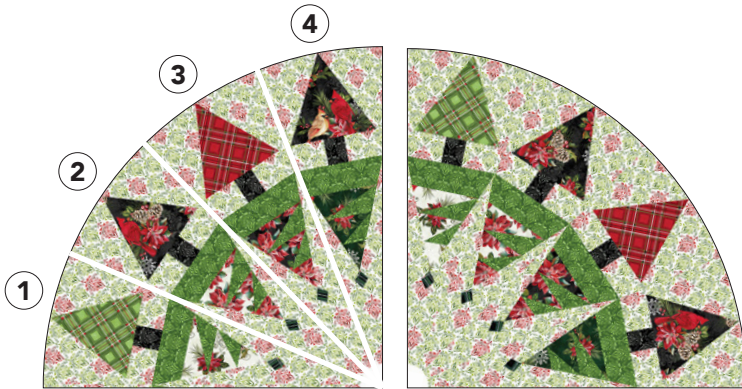

6. MAKE (4) QUARTER UNITS



7. MAKE (2) HALF UNITS

8. SEW HALF UNITS TOGETHER

LEAVE  
THIS SIDE  
OPEN





# Pines and Twine Tree Skirt

## FOUNDATION 1

PRINT 16 PAGES  
AT 100% SCALE

1"  
TEST  
PRINT

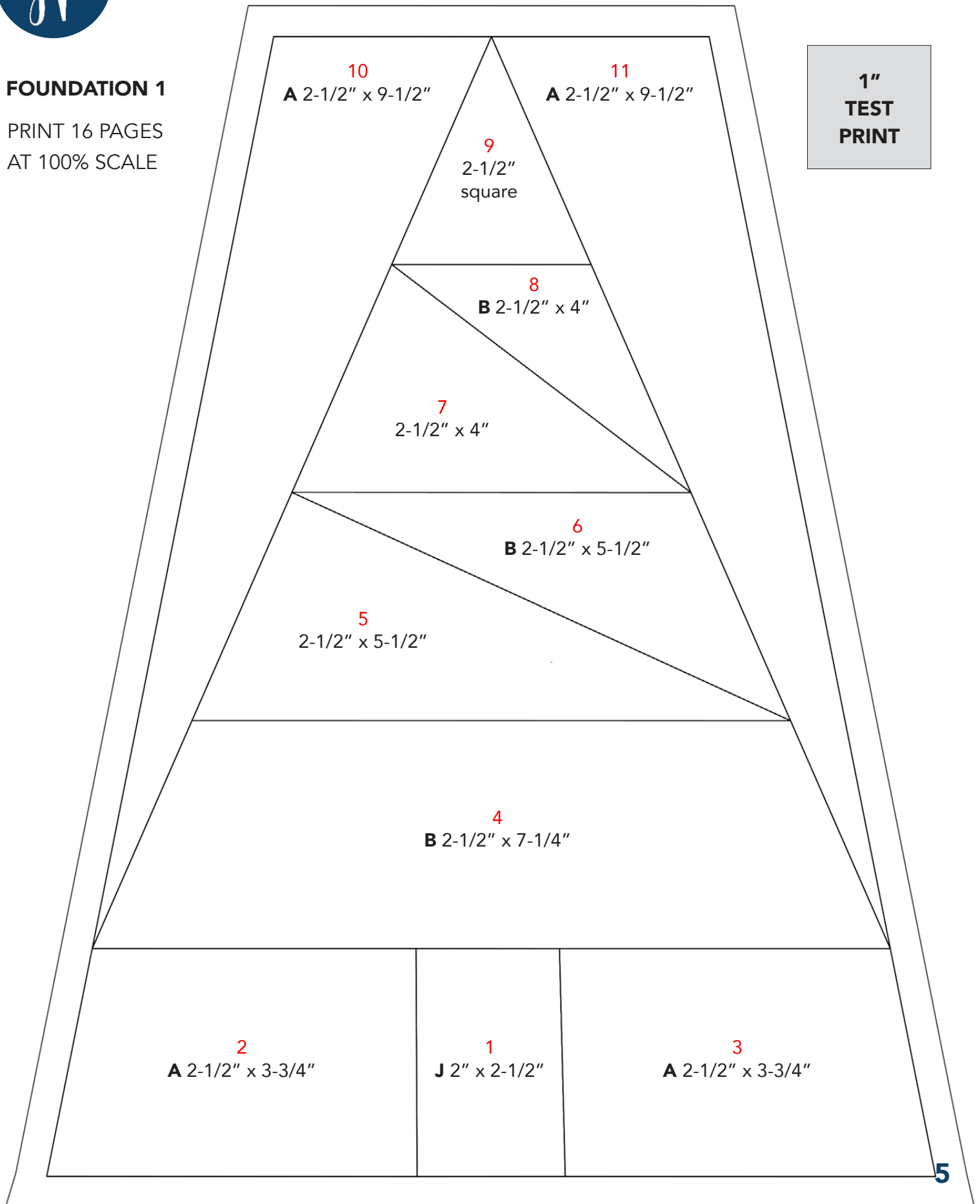



# FOUNDATION 2

PRINT 2 PAGES  
AT 100% SCALE

1"  
TEST  
PRINT

# Pines and Twine Tree Skirt

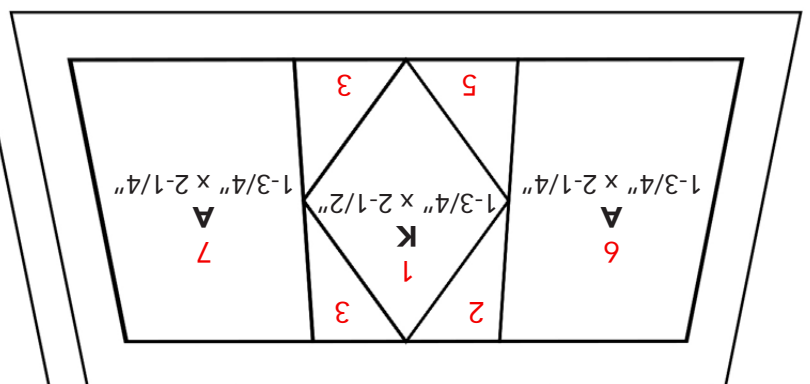
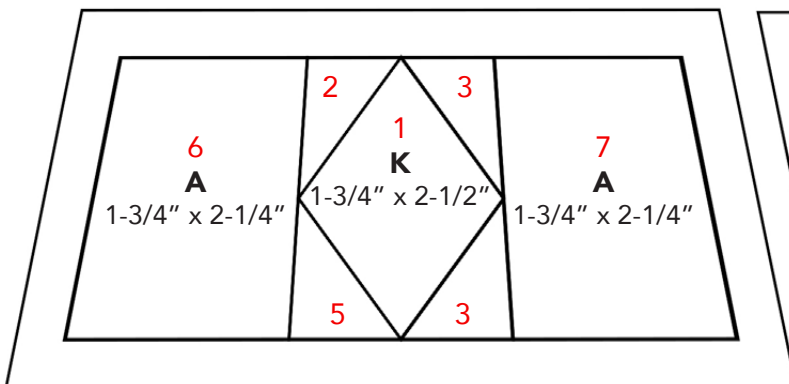
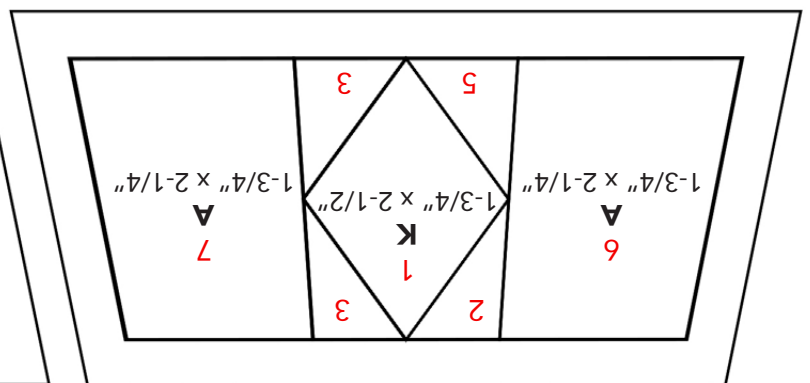
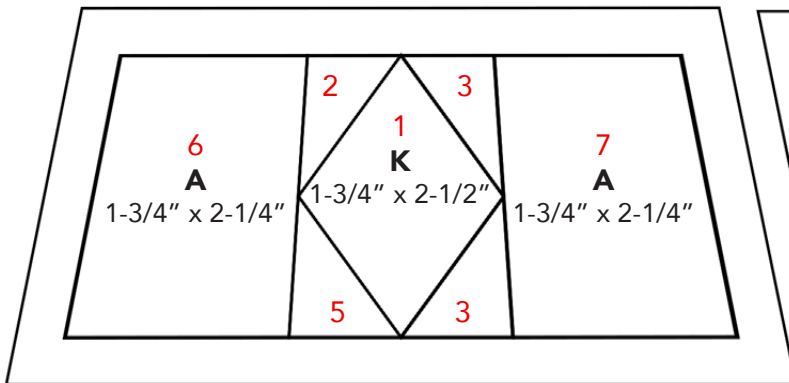
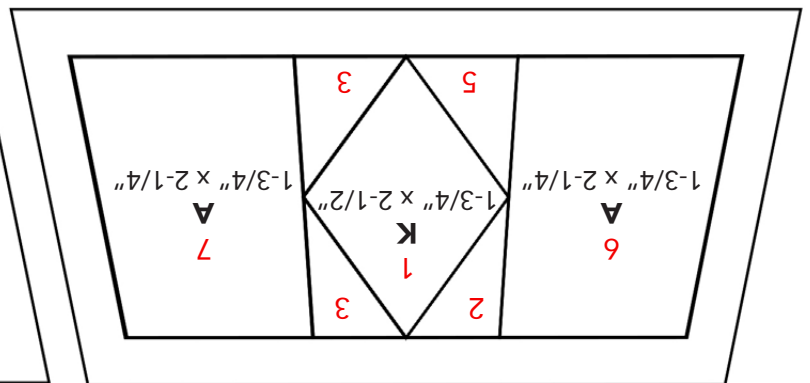
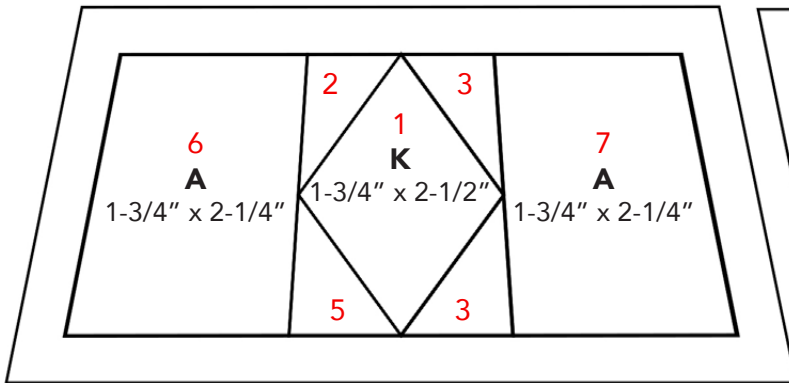
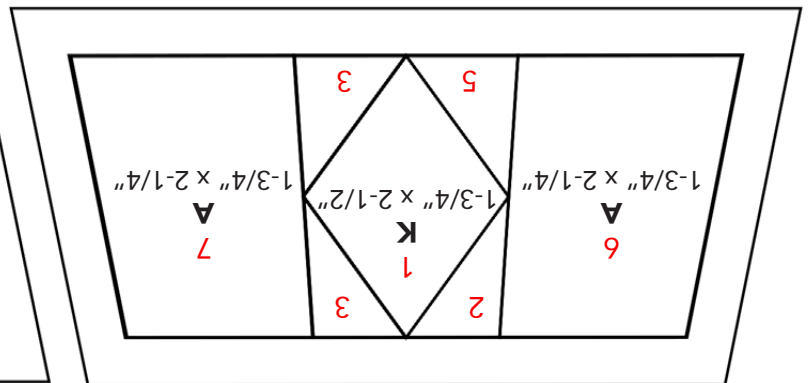
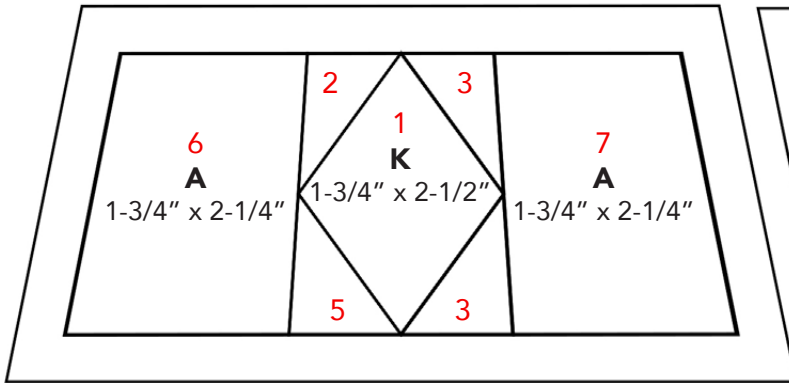

# Pines and Twine Tree Skirt

Template 1

Cut (16) A

1/4" seam allowance included

1"  
TEST  
PRINT

PRINT AT 100% SCALE

Template 2

Cut (16) A

1/4" seam allowance included





# Pines and Twine Tree Skirt

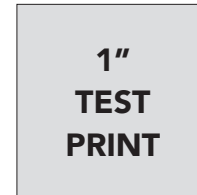
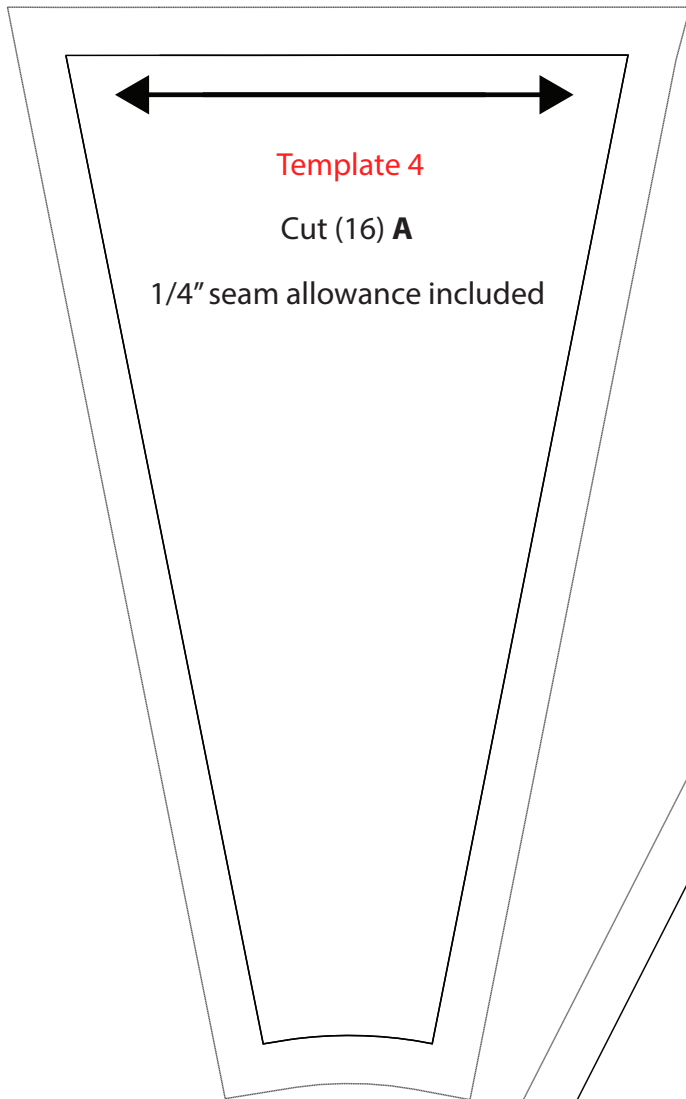

PRINT AT 100% SCALE

